

DATA SHEET

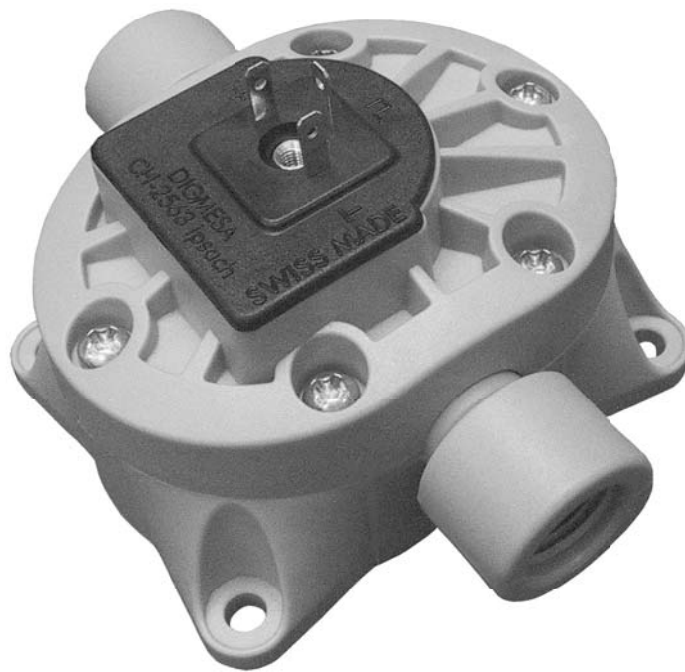

DIGMESA

EPI PEEK chemistry
Part number: 930-0201/CV01

Digmesa AG, Keltenstrasse 31, CH-2563 Ipsach / Switzerland
Phone +41 (32) 332 77 77, Fax +41 (32) 332 77 88
www.digmesa.com

Version 01 EPI 930-0201/CV01 GB Page 1-5

General Description

The EPI flowmeter is specifically suitable for fluid flow rate measurement of highly viscous media such as syrup, oil or detergent concentrates. Thanks to its special design and the epicycloid wheels, the EPI flowmeter is highly precise and allows extremely accurate flow measurement with minimal pressure loss.

Specific applications: Highly viscous media, high temperatures, high flow rates with low pressure loss and good chemical resistance.

Approvals / Standards

EN55014-1:00+A1:01+A2:02, EN61000-6-3:01+A11:04, IEC61000-6-3:06(ed.2.0), EN61000-3-2:06, IEC61000-3-2:05(ed.3.0), EN61000-3-3:95+A1:01+A2:05, IEC61000-3-3:94+A1:01+A2:05(Cons.ed 1.2), EN55014-2:97+A1:01, EN61000-6-1:01, IEC61000-6-1:05(ed.2)



Material:

Housing:	PEEK 150 GL 30 natur
Bearing pin:	Aluminium oxide (Al ₂ O ₃)
O-ring:	FPM (Viton) EPDM on request
Turbine:	PEEK
Magnets:	NdFeB (Neodym) (not in contact with the medium)

Technical data:

Flow rate:	0.06 - 16.0 l/min depending on viscosity
Measuring accuracy:	+/- 1.0% depending on viscosity
Repetition:	< +/- 0.25%
Temperature range:	-10°C to +65°C 14°F to 149°F
Pressure range:	10 bar at 20°C 145 psi /68°F
Mounting position:	Horizontal recommended
Nozzle size:	Ø 7.0 mm
Viscosity range:	approx. 5 - 8000 centistokes

Electrical connection ratings:

Power supply:	4.5–24 V DC
Consumption:	5 mA to max. 13 mA
Signal connection:	Open collector NPN
Signal voltage:	0 V GND
Signal load:	max. 20 mA
Leakage current:	max. 10 µA
Connections:	3-pin AMP 2.8 x 0.8 mm
Signal:	Square-wave output
Duty Cycle:	50% / ±3%

Dimensions in mm:

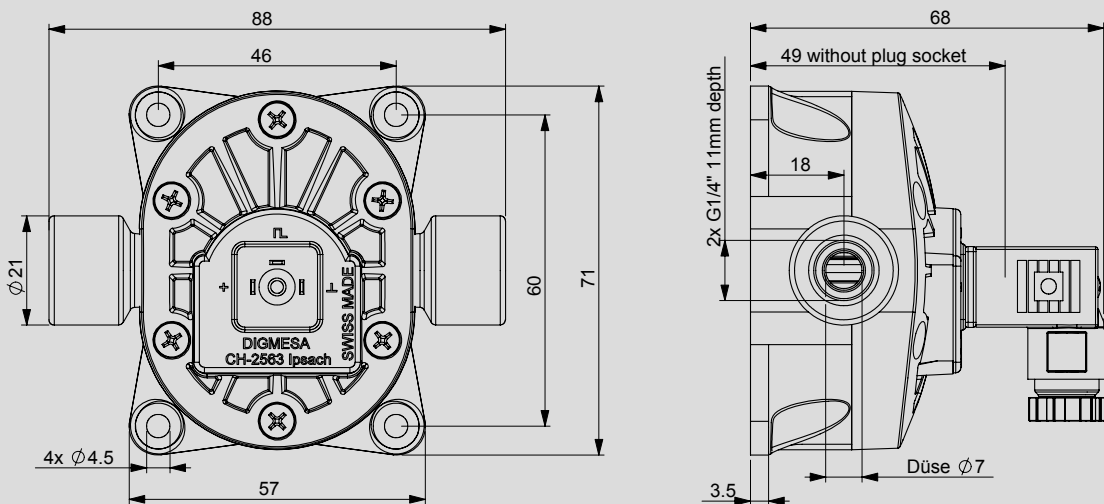

Included in the delivery:

3-pin solenoid socket
Item number: 941-0002/3



We reserve the right to make modifications in the interests of technical progress.

RESISTANCE

Special regulations which must be complied with by the flowmeter manufacturer apply to each country, e.g. CE, NSF, FDA and SK. The various media flowing through the flowmeter differ from application to application. You are advised to enquire with the medium manufacturer as to whether the entire installation and the flowmeter are resistant to the medium itself (see Material)!

ELECTRONIC

DIGMESA electronic circuitry is always designed for operation with DIGMESA flowmeters. Please note the following if connecting to other electronic circuitry:

- The flowmeter does not supply an output voltage but switches the signal terminal to 0 V ground (actuated) or leaves it open (non-actuated)
- There must be a pull-up resistor between power supply + and signal depending on electronic circuitry!

Version 01 EPI 930-0201/CV01 G8 Page 2-5

Interface Connection: Examples Open Collector

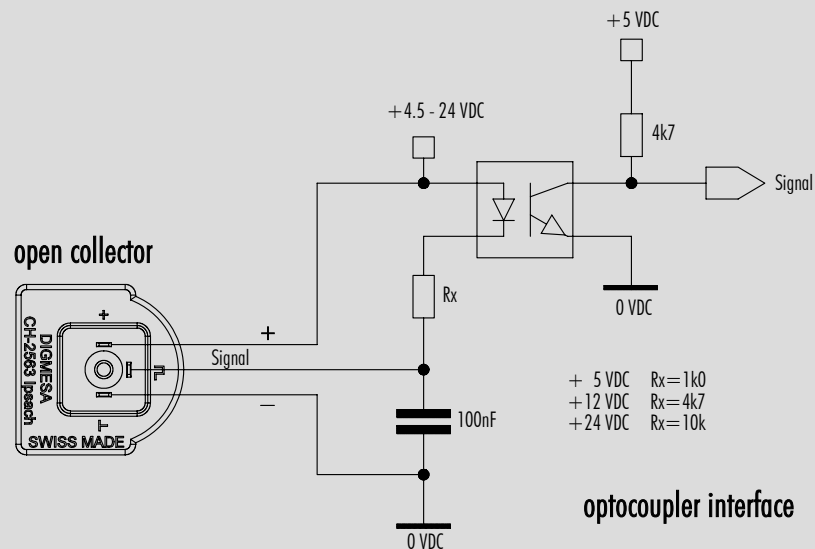
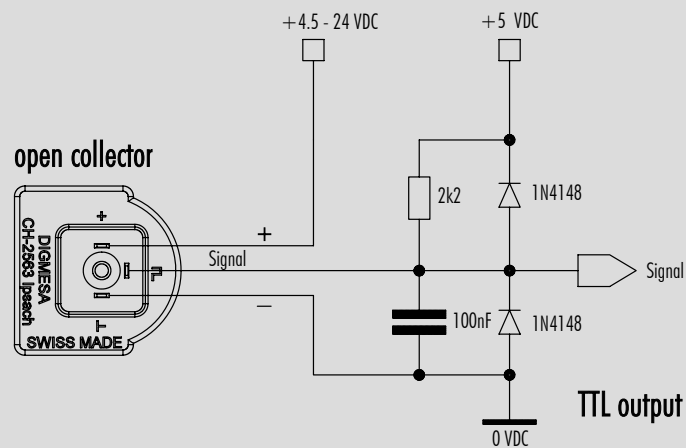
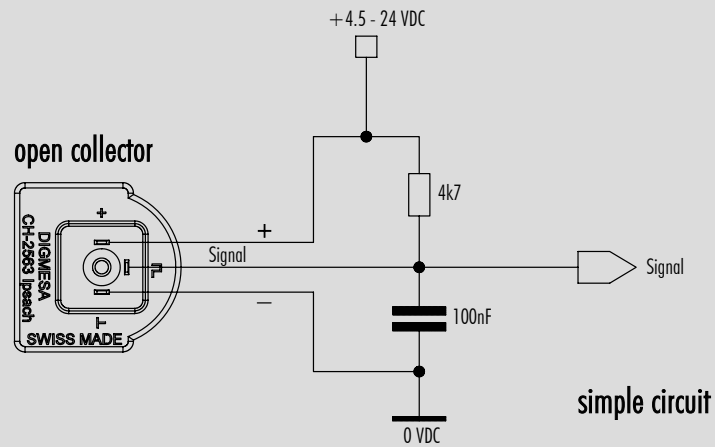

Digimesa

Measurement Curve EPI Ø7.00 mm

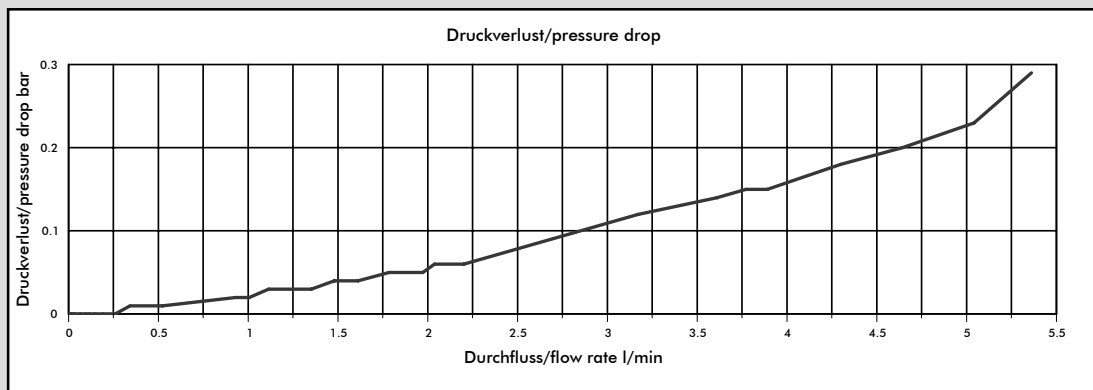
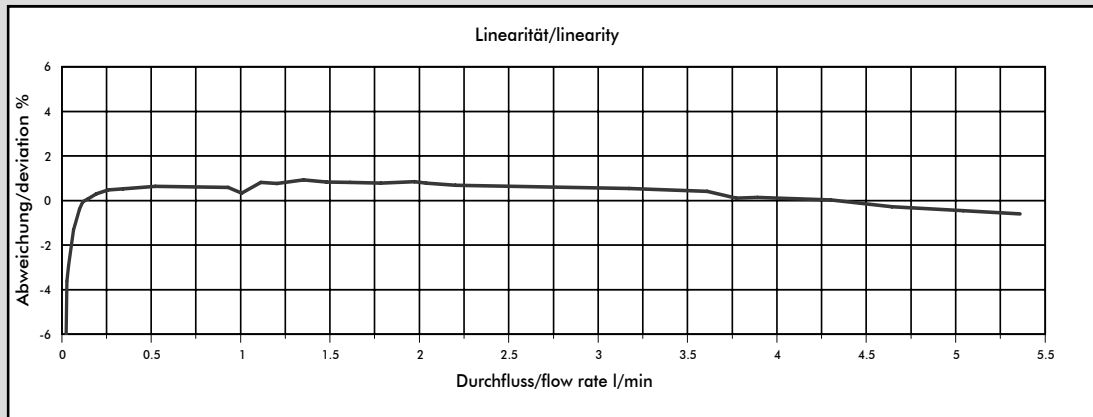

Medium for these linearity and pressure loss curves: Cola syrup (approx. 24 centistokes).

Nozzle size	Pulses/litre	g/pulse	min. flow rate in litres/min at Linear start	max. flow rate in litres/min	Pressure loss
Ø 7.00 mm	462	2.166	0.0653	5.35	0.29

The min. and max. flow rate and the pressure loss may vary depending on viscosity.

The values specified must be considered as approximate values.

The number of pulses per litre may differ depending on medium and installation.

We recommend to calibrate the number of pulses per litre in line with the complete installation.

MEASUREMENT TIPS

- Ensure that there is no fast-pulsatory movement of the media
- Ensure that there are no reverse pressure surges
- Ensure that there is no air in the system
- Note the mounting position of the flowmeter
- Min/max flow should be in the linear range of the selected flowmeter
- Clean the system at appropriate intervals
- Avoid electrical current peaks
- Incorrect cabling of power supply +, signal and ground will destroy the flowmeter
- Do not mechanically load electrical contacts
- Avoid moisture on the electrical contacts
- Avoid stray pick-up via the cable (Do not lay cables in parallel with high current loads)

