

DATA SHEET



DIGIMESA

FHK LCD G1/4" Arnite

Part number: 937-15XX/21

Digimesa AG, Keltenstrasse 31, CH-2563 Ipsach / Switzerland

Phone +41 (32) 332 77 77, Fax +41 (32) 332 77 88

www.digimesa.com

Version 01 FHK G1/4" LCD 937-15XX/21 GB Page 1-10

General Description

The Flow Sensor FHK LCD is an universally applicable control device and Flow Sensor. It's working range can be individually defined according to its nozzle size. It guarantees most precise fluid measurements. Excellent suitably to the monitoring of ion exchanger filter cartridges and for the treatment of water.

Specific applications: Inlet and outlet on the same side. Time and date administration, upward or backwards counters, history with date, instantaneous value announcement, automatic impulse calibration, litres and /or alarm-date, securit code prevents tempering by unauthorised persons. Current supply over lithium battery. With a battery change all attitudes and values are stored.

Approvals / Standards

EMV-Standard:
EN 61326: 1997 + A1:1998 + A2: 2001
(IEC 61326: 2002)



Material:

Housing: PBT 35%GF (Arnite)
Bearing pin: Inox 1.4305 (18/8)
Nozzle: Inox 1.4305 (18/8)
O-ring: MVQ (Silikon)
Turbine: PVDF
Magnets: Keramik Sr Fe O
(in contact with the medium)
Screw: PT-screws
(Phillips cross recessed)

Technical data:

Flow rate: 0.041 - 6 l/min depending on the nozzle diameter
Measuring accuracy: +/- 2.0%
Repetition: < +/- 0.25%
Temperature range: 0°C to +60°C
32°F to 140°F
Pressure range: 10 bar at 20°C
145 psi /68°F
Mounting position: Horizontal recommended
Nozzle size: Ø 1.0, 1.2, 1.5, 2.0, 2.5, 3.3 mm

Technical data upper section:

Splash-proof: IP X4
Limit-measurement: 1 - 99999 Litres
Pulses/litre: 1 - 65000
Statistics memory: the last 5 zero resets
Display: 5 digit
Counter: upwart 0 to 99999 litres with and without limit downwart 99999 to -9999 litres
Instantaneous value: l/min
Battery: lithium CR 2032

Dimensions in mm:

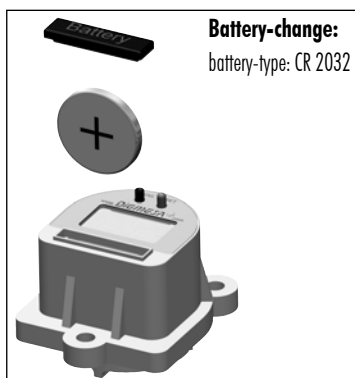
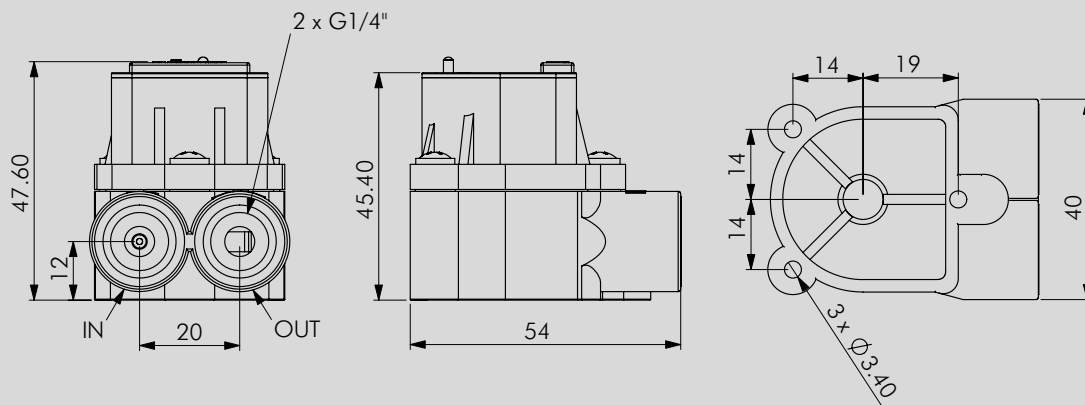

We reserve the right to make modifications in the interests of technical progress.

RESISTANCE

Special regulations which must be complied with by the flowmeter manufacturer apply to each country, e.g. CE, NSF, FDA and SK. The various media flowing through the flowmeter differ from application to application. You are advised to enquire with the medium manufacturer as to whether the entire installation and the flowmeter are resistant to the medium itself (see Material)!

FHK-LCD query and display function

<p>Upcounter (1 on the display) Displays the flow quantity in litres. Measuring range without limit function: 0 to 99999 litres with max. 3 places after the decimal point (dependent on the number of pulses). With limit function: 0 to 99999 litres (no place after the decimal point). „OF“ (OverFlow) is displayed if 99999 is exceeded.</p> <p>Alarm functions: Display blinks when the limit value or the alarm date is reached.</p> <p>Downcounter (2 on the display) Displays the remaining quantity in litres through to alarm.</p>	<p>Measuring range without limit function: Downcounter is deactivated. „OFF“ is shown on the display. With limit function: 99999 to -9999 litres (no place after the decimal point). „OF“ (OverFlow) is displayed if -9999 is undershot.</p> <p>Alarm functions: Display blinks when value 0 litres or alarm date is reached.</p> <p>Instantaneous value (3 on the display) Displays the current flow rate in l/min. Measuring range: 0 to 999.99 l/min with 2 places after the decimal point.</p> <p>Time / date (4 on the display) Displays the time and the date.</p>	<p>Alarm-date (5 on the display) Without time limit function: The alarm date is deactivated. „OFF“ is shown on the display. With time limit function: The alarm date is displayed.</p> <p>History 1-5 The 5 last history values are displayed. They are displayed consecutively with the memory level (1-5). The data of the last reset is saved at memory level 1. The following values are displayed as a „ticker“ text:</p> <ul style="list-style-type: none"> • HL (History Liter) flow quantity • Hd (History date) reset-date
---	--	---

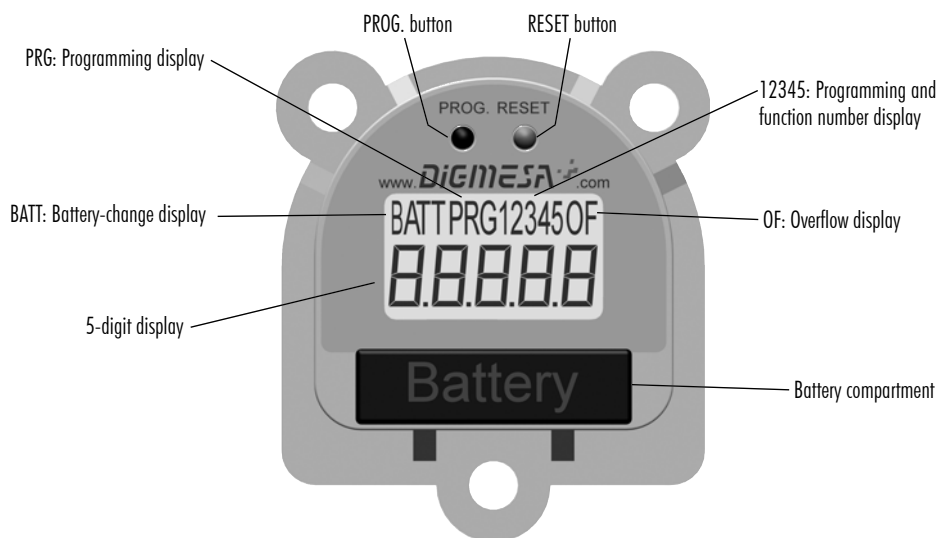

FHK-LCD programming function

<p>PRG Setting the security code 4-digit security code. The security function is deactivated if the value of the security code is 0000.</p> <p>PRG1 Setting time/date 24 h time format (hh-mm)/date (DD.MM.YY). The current date is saved under Hd (history date) each time the unit is reset.</p>	<p>PRG2 Setting the limit value Limit value in litres (0 to 99999) The limit value corresponds to the number of litres before an alarm is triggered and is the initial value when downcounting. The limit function and downcounter are deactivated if the limit value is 0.</p> <p>PRG3 Setting the time limit value Time limit value in months (0 to 99) The time limit value corresponds to the number of months before an alarm is triggered. The time limit function is deactivated if the time limit value is 0.</p>	<p>PRG4 Setting the calibration value (manual) Calibration value in pulses per litre (1 to 65000)</p> <p>PRG5 Setting the calibration value (automatic) This function automatically calculates and sets the calibration value of the entire installation and the medium to be measured. The weight of the flow medium is entered in gram.</p>
--	---	---



Measurement Curve FHK 1.00 mm

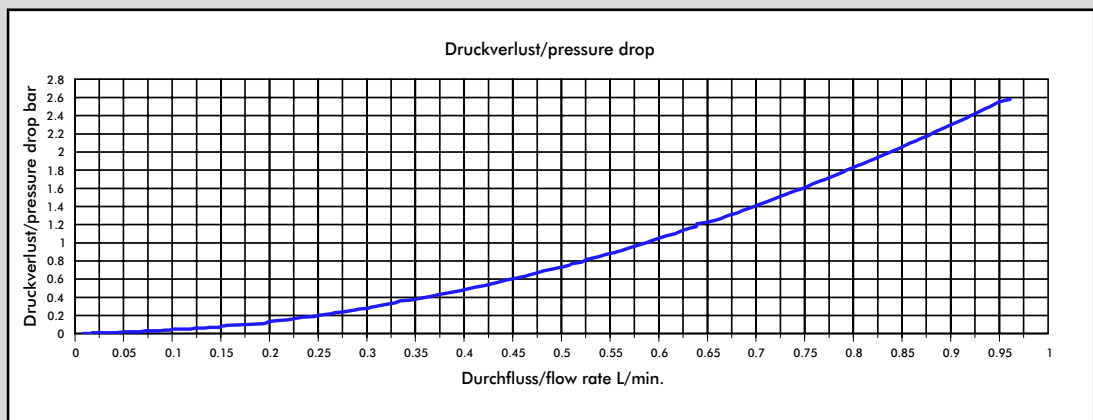
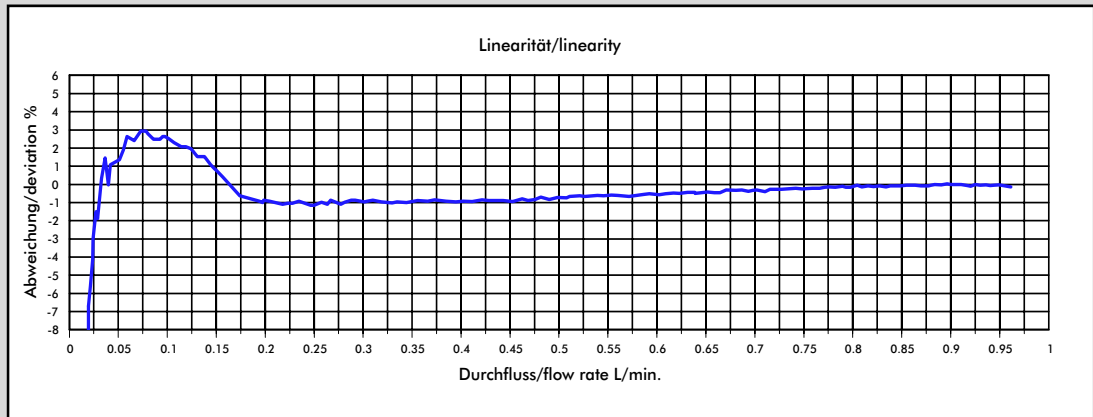

Medium: Water / max. Pressure: 3.3 bar

Nozzle size	Pulses/litre	g/pulse	min. flow rate in litres/min at Linear start	max. flow rate in litres/min	Pressure loss
Ø 1.00 mm	4446	0.2249	0.0274	0.5867	1.00
Ø 1.20 mm	3574	0.2797	0.0315	0.7777	1.00
Ø 1.50 mm	2772	0.3608	0.0417	1.3434	1.00
Ø 2.00 mm	2026	0.4934	0.1109	2.3268	1.00
Ø 2.50 mm	1508	0.6626	0.0673	2.7421	0.60
Ø 3.30 mm	1018	0.9806	0.1396	5.3606	1.00

MEASUREMENT TIPS

- Ensure that there is no fast-pulsatory movement of the media
- Ensure that there are no reverse pressure surges
- Ensure that there is no air in the system
- Note the mounting position of the flowmeter
- Min/max flow should be in the linear range of the selected flowmeter
- Clean the system at appropriate intervals
- Avoid humidity at the battery and at the electrical contacts
- Avoid stray pick-up via the cable (Do not lay cables in parallel with high current loads)

The values specified must be considered as approximate values.

The number of pulses per litre may differ depending on medium and installation.

We recommend to calibrate the number of pulses per litre in line with the complete installation.

Measurement Curve FHK 1.20 mm

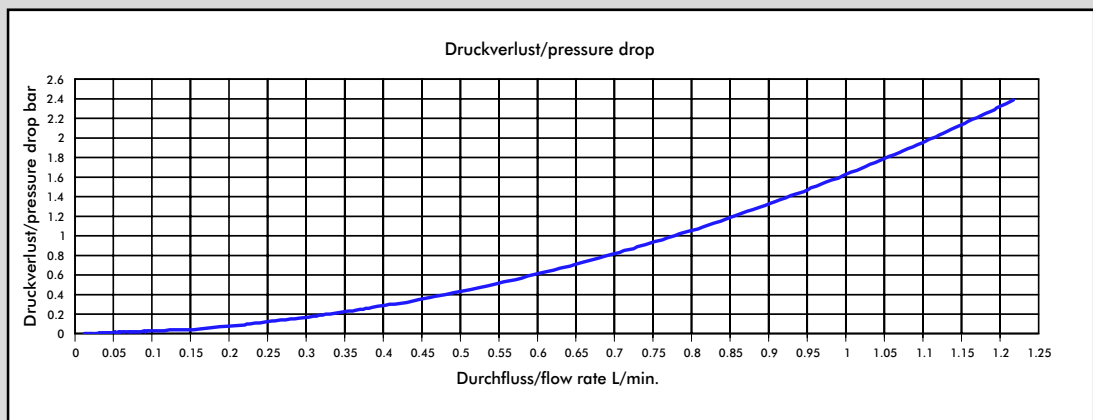
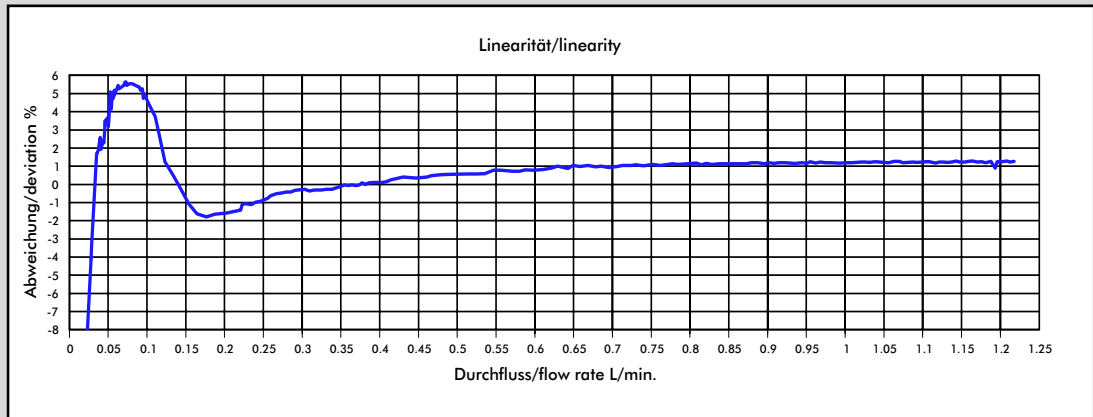

Medium: Water / max. Pressure: 3.3 bar

Nozzle size	Pulses/litre	g/pulse	min. flow rate in litres/min at Linear start	max. flow rate in litres/min	Pressure loss
Ø 1.00 mm	4446	0.2249	0.0274	0.5867	1.00
Ø 1.20 mm	3574	0.2797	0.0315	0.7777	1.00
Ø 1.50 mm	2772	0.3608	0.0417	1.3434	1.00
Ø 2.00 mm	2026	0.4934	0.1109	2.3268	1.00
Ø 2.50 mm	1508	0.6626	0.0673	2.7421	0.60
Ø 3.30 mm	1018	0.9806	0.1396	5.3606	1.00

MEASUREMENT TIPS

- Ensure that there is no fast-pulsatory movement of the media
- Ensure that there are no reverse pressure surges
- Ensure that there is no air in the system
- Note the mounting position of the flowmeter
- Min/max flow should be in the linear range of the selected flowmeter
- Clean the system at appropriate intervals
- Avoid humidity at the battery and at the electrical contacts
- Avoid stray pick-up via the cable (Do not lay cables in parallel with high current loads)

The values specified must be considered as approximate values.

The number of pulses per litre may differ depending on medium and installation.

We recommend to calibrate the number of pulses per litre in line with the complete installation.

Measurement Curve FHK 1.50 mm

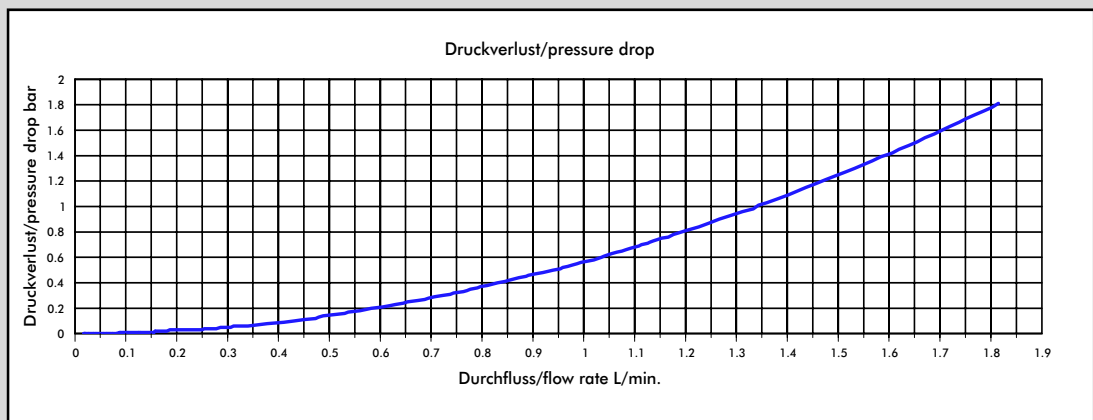
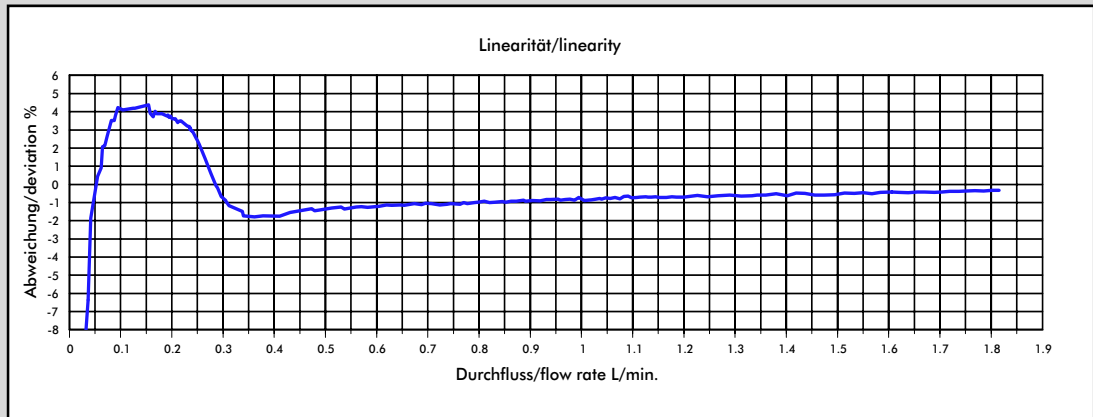

Medium: Water / max. Pressure: 3.3 bar

Nozzle size	Pulses/litre	g/pulse	min. flow rate in litres/min at Linear start	max. flow rate in litres/min	Pressure loss
Ø 1.00 mm	4446	0.2249	0.0274	0.5867	1.00
Ø 1.20 mm	3574	0.2797	0.0315	0.7777	1.00
Ø 1.50 mm	2772	0.3608	0.0417	1.3434	1.00
Ø 2.00 mm	2026	0.4934	0.1109	2.3268	1.00
Ø 2.50 mm	1508	0.6626	0.0673	2.7421	0.60
Ø 3.30 mm	1018	0.9806	0.1396	5.3606	1.00

MEASUREMENT TIPS

- Ensure that there is no fast-pulsatory movement of the media
- Ensure that there are no reverse pressure surges
- Ensure that there is no air in the system
- Note the mounting position of the flowmeter
- Min/max flow should be in the linear range of the selected flowmeter
- Clean the system at appropriate intervals
- Avoid humidity at the battery and at the electrical contacts
- Avoid stray pick-up via the cable (Do not lay cables in parallel with high current loads)

The values specified must be considered as approximate values.

The number of pulses per litre may differ depending on medium and installation.

We recommend to calibrate the number of pulses per litre in line with the complete installation.

Measurement Curve FHK 2.00 mm

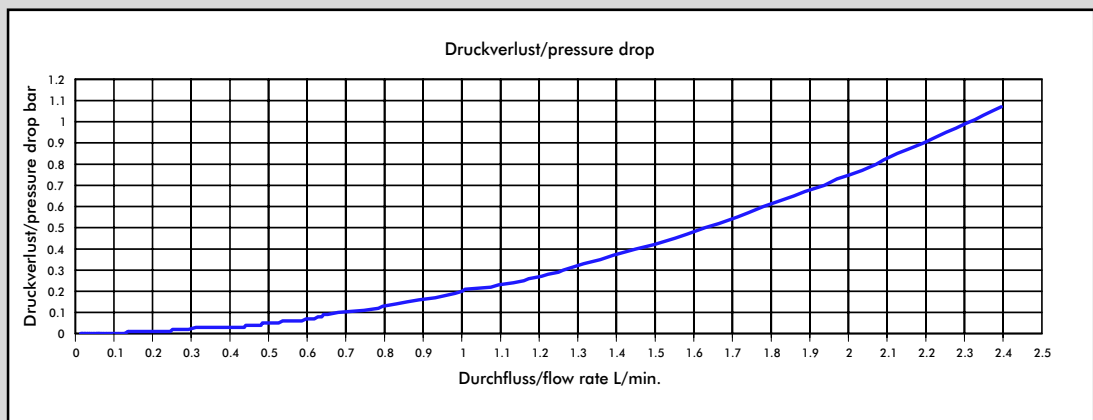
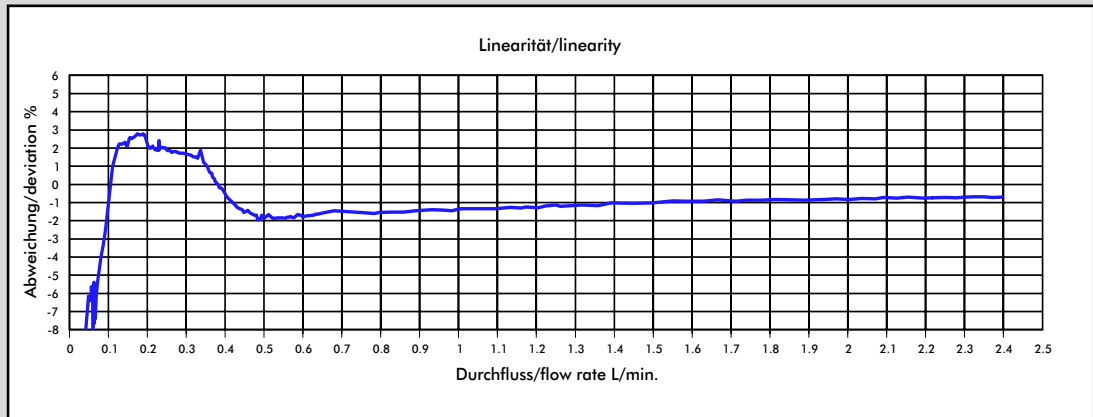

Medium: Water / max. Pressure: 3.3 bar

Nozzle size	Pulses/litre	g/pulse	min. flow rate in litres/min at Linear start	max. flow rate in litres/min	Pressure loss
Ø 1.00 mm	4446	0.2249	0.0274	0.5867	1.00
Ø 1.20 mm	3574	0.2797	0.0315	0.7777	1.00
Ø 1.50 mm	2772	0.3608	0.0417	1.3434	1.00
Ø 2.00 mm	2026	0.4934	0.1109	2.3268	1.00
Ø 2.50 mm	1508	0.6626	0.0673	2.7421	0.60
Ø 3.30 mm	1018	0.9806	0.1396	5.3606	1.00

MEASUREMENT TIPS

- Ensure that there is no fast-pulsatory movement of the media
- Ensure that there are no reverse pressure surges
- Ensure that there is no air in the system
- Note the mounting position of the flowmeter
- Min/max flow should be in the linear range of the selected flowmeter
- Clean the system at appropriate intervals
- Avoid humidity at the battery and at the electrical contacts
- Avoid stray pick-up via the cable (Do not lay cables in parallel with high current loads)

The values specified must be considered as approximate values.

The number of pulses per litre may differ depending on medium and installation.

We recommend to calibrate the number of pulses per litre in line with the complete installation.

Measurement Curve FHK 2.50 mm

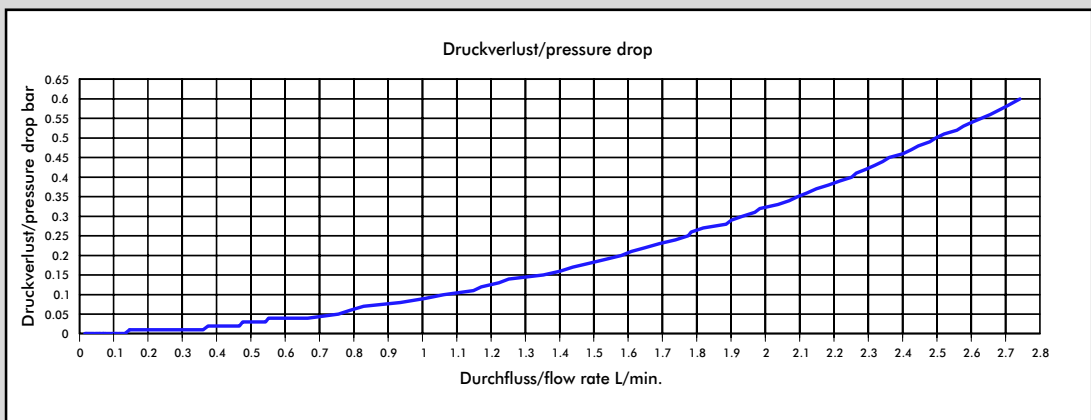
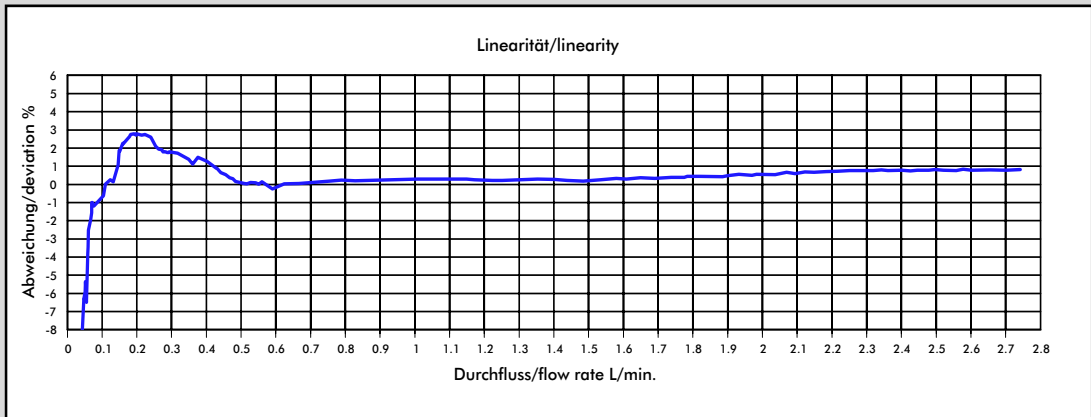

Medium: Water / max. Pressure: 3.3 bar

Nozzle size	Pulses/litre	g/pulse	min. flow rate in litres/min at Linear start	max. flow rate in litres/min	Pressure loss
Ø 1.00 mm	4446	0.2249	0.0274	0.5867	1.00
Ø 1.20 mm	3574	0.2797	0.0315	0.7777	1.00
Ø 1.50 mm	2772	0.3608	0.0417	1.3434	1.00
Ø 2.00 mm	2026	0.4934	0.1109	2.3268	1.00
Ø 2.50 mm	1508	0.6626	0.0673	2.7421	0.60
Ø 3.30 mm	1018	0.9806	0.1396	5.3606	1.00

MEASUREMENT TIPS

- Ensure that there is no fast-pulsatory movement of the media
- Ensure that there are no reverse pressure surges
- Ensure that there is no air in the system
- Note the mounting position of the flowmeter
- Min/max flow should be in the linear range of the selected flowmeter
- Clean the system at appropriate intervals
- Avoid humidity at the battery and at the electrical contacts
- Avoid stray pick-up via the cable (Do not lay cables in parallel with high current loads)

The values specified must be considered as approximate values.

The number of pulses per litre may differ depending on medium and installation.

We recommend to calibrate the number of pulses per litre in line with the complete installation.

Measurement Curve FHK 3.30 mm

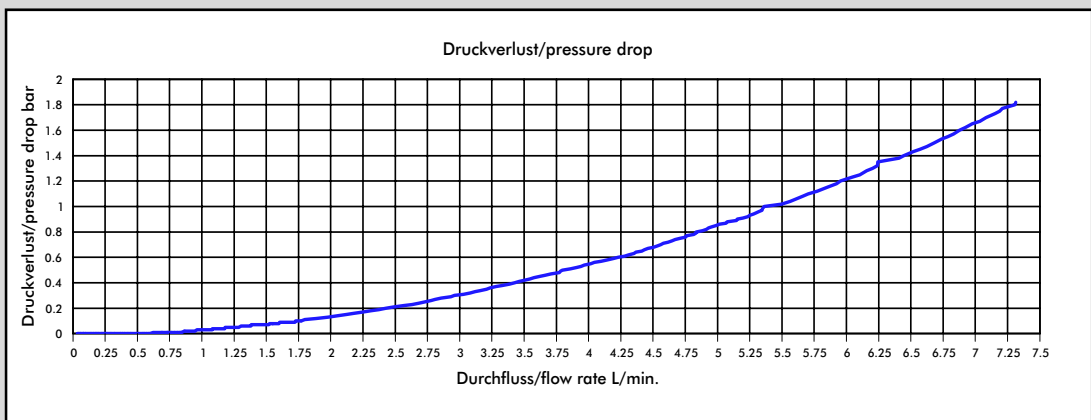
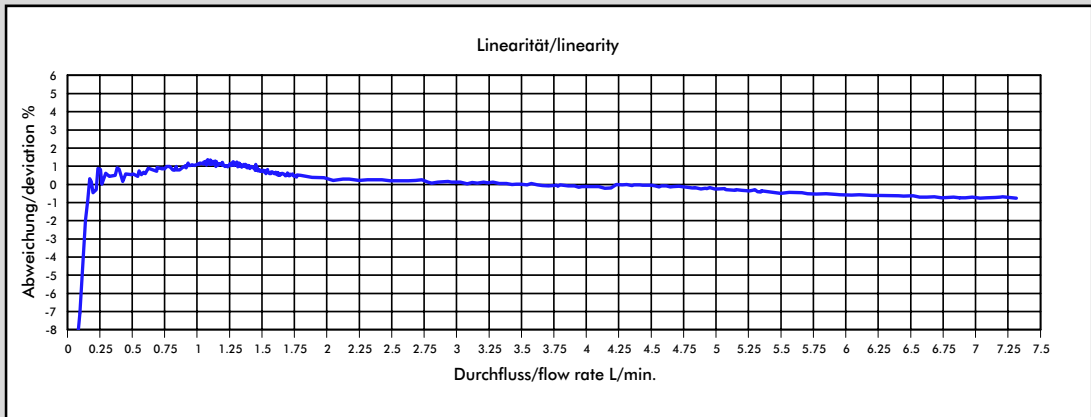

Medium: Water / max. Pressure: 3.3 bar

Nozzle size	Pulses/litre	g/pulse	min. flow rate in litres/min at Linear start	max. flow rate in litres/min	Pressure loss
Ø 1.00 mm	4446	0.2249	0.0274	0.5867	1.00
Ø 1.20 mm	3574	0.2797	0.0315	0.7777	1.00
Ø 1.50 mm	2772	0.3608	0.0417	1.3434	1.00
Ø 2.00 mm	2026	0.4934	0.1109	2.3268	1.00
Ø 2.50 mm	1508	0.6626	0.0673	2.7421	0.60
Ø 3.30 mm	1018	0.9806	0.1396	5.3606	1.00

MEASUREMENT TIPS

- Ensure that there is no fast-pulsatory movement of the media
- Ensure that there are no reverse pressure surges
- Ensure that there is no air in the system
- Note the mounting position of the flowmeter
- Min/max flow should be in the linear range of the selected flowmeter
- Clean the system at appropriate intervals
- Avoid humidity at the battery and at the electrical contacts
- Avoid stray pick-up via the cable (Do not lay cables in parallel with high current loads)

The values specified must be considered as approximate values.

The number of pulses per litre may differ depending on medium and installation.

We recommend to calibrate the number of pulses per litre in line with the complete installation.

